



# VOLVO V50

LISTA DE PRETURI 2012.V3.14 NOI 2011







## VERSIUNILE VOLVO V50

VOLVO V50	Putere	Cutie Viteze	Pret Euro fara TVA	Pret Euro cu TVA
<b>V50 KINETIC (standard)</b>				
<b>Benzina</b>				
2,0	145	MT5	18,700	23,188
T5	230	G5	26,600	32,984
<b>Diesel</b>				
D2	115	MT6	18,700	23,188
DRIVe	115	MT6	19,200	23,808
D3	150	MT6	21,300	26,412
D3	150	G6	22,900	28,396
D4	177	MT6	24,600	30,504
D4	177	G6	26,200	32,488

	Pret Euro fara TVA	Reducere fara TVA	Pret redus fara TVA	Pret Euro cu TVA
<b>V50 BUSINESS EDITION</b>	1,990	940	1,050	1,302
<b>Suplimentar fata de Standard</b>				
<i>Pilot automat</i>	<i>Tapiterie Textil/Tricotex Dalaro</i>			
<i>Comenzi audio pe volan</i>	<i>Ornamente interioare aluminiu pe panouri usi / consola</i>			
<i>Sistem audio High Performance, 8 difuzoare, 4x40W</i>	<i>Lumini permanente LED in spoiler fata</i>			
<i>Radio/CD/Mp3/conexiune USB</i>	<i>16" jante aliaj, CONVECTOR, 205/55 R16</i>			
<i>Senzor de parcare cu avertizare sonora pentru mersul inapoi</i>	<i>Maner portbagaj cromat</i>			
<i>Bluetooth integrat</i>				

	Pret Euro fara TVA	Reducere fara TVA	Pret redus fara TVA	Pret Euro cu TVA
<b>V50 BUSINESS PRO EDITION</b>	5,530	2,280	3,250	4,030
<b>Suplimentar fata de Standard</b>				
<i>Pilot automat</i>	<i>Cotiera spate cu suport pentru pahare</i>			
<i>Comenzi audio pe volan</i>	<i>Oglinzi exterioare rabatabile electric cu lumini incorporate</i>			
<i>Sistem audio High Performance, 8 difuzoare, 4x40W</i>	<i>Oglinda retrovizoare cu efect heliomat</i>			
<i>Radio/CD/Mp3/conexiune USB</i>	<i>Sistem de navigatie (RTI) fara TV, cu comanda pe volan</i>			
<i>Senzor de parcare cu avertizare sonora pentru mersul inapoi</i>	<i>Senzor umiditate</i>			
<i>Bluetooth integrat</i>	<i>Tapiterie Piele</i>			
<i>Ornamente interioare aluminiu pe panouri usi / consola</i>	<i>Senzor de ploaie</i>			
<i>Lumini permanente LED in spoiler fata</i>	<i>Instrumente de bord tip watch dial</i>			
<i>16" jante aliaj, CONVECTOR, 205/55 R16</i>	<i>Scaun pasager ajustabil pe inaltime cu suport lombar reglabil</i>			
<i>Maner portbagaj cromat</i>				

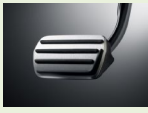
	Pret Euro fara TVA	Reducere fara TVA	Pret redus fara TVA	Pret Euro cu TVA
<b>V50 RDESIGN EDITION (nu pentru DRIVe)</b> cod 998916	5,090	2,790	2,300	2,852
<b>Suplimentar fata de Standard</b>				
			<i>Ornamente interioare aluminiu Rdesign</i> <i>Capace oglinzi exterioare satinat Rdesign</i> <i>Covorase sport Rdesign</i> <i>Volan trei spite imbracat in piele cu insertii de aluminiu Rdesign</i> <i>Schimbator de viteze imbracat in piele cu insertii de aluminiu RDesign</i> <i>Tapiterie piele Rdesign</i> <i>Body kit</i> <i>Eleron spate</i> <i>Grila Rdesign</i> <i>Pedale sport Rdesign</i> <i>Comenzi audio pe volan</i> <i>Pilot automat</i> <i>Instrumente de bord Rdesign</i> <i>17" jante aliaj, CRATUS, 205/50 R17</i> <i>Sistem audio High Performance, 8 difuzoare, 4x40W</i> <i>Radio/CD/Mp3/conexiune USB</i> <i>Bluetooth integrat</i> <i>Lumini permanente LED in spoiler fata</i> <i>Senzor de parcare cu avertizare sonora pentru mersul inapoi</i>	
				



## DOTARI OPTIONALE VOLVO V50

Cod		Pret Euro fara TVA	Pret Euro cu TVA	Kinetic	Business Ed.	Rdesign Ed.	Business Pro Ed
<b>EXTERIOR</b>							
30	Trapa	898	1,114	0	0	0	0
729	Bare longitudinale pe acoperis (argintii / aluminiu)	254	315	0	0	0	0
605 / 65	Faruri Adaptive Bi-Xenon inclusiv sistem de spalare (65)	1,126	1,396	0	0	0	0
65	Sistem spalare faruri	279	346	0	0	0	0
16	Proiectoare de ceata in spoiler fata (nu pentru DRIVE ; scoate din std.667, daca este cazul)	169	210	0	0	0	0
		0	0	-	0	0	0
671	Lumini permanente (obligatoriu cu 16, scoate 667 din std. Business Ed./Rdesign)	0	0	0	-	-	-
667	Lumini permanente LED in spoiler fata (nu impreuna cu 16/671)	195	242	0	S	S	S
167	Oglinzi exterioare rabatabile electric cu lumini incorporate	237	294	0	0	0	S
168	Oglinda retrovizoare cu efect heliomat (std.DRIVE cu Start-Stop)	161	200	0	0	0	S
454	Oglinda retrovizoare cu efect heliomat, cu busola (include cod 168)	220	273	0	0	0	-
		59	73	-	-	-	0
	numai pentru DRIVE (1.6d cu Start-Stop)	59	73	0	0	0	-
370	Senzor de ploaie	93	115	0	0	0	S
727	Senzor umiditate (obligatoriu cu cod 168 sau 454 ; std.DRIVE cu Start-Stop)	42	52	0	0	0	S
273	Preincalzitor cu temporizare (nu pentru 1.6) - scoate din std. PTC,daca exista	999	1,239	0	0	0	0
308	Fara emblema motorizare (nu pentru DRIVE)	0	0	0	0	0	0
<b>INTERIOR</b>							
439	AQS - sistem control calitate aer (doar impreuna cu 7,ECC)	0	0	0	0	0	0
	Scaun pasager cu reglaj electric si memorie pentru scaun sofer si pasager (obligatoriu cu cod						
10	47/385,nu cu 57)	381	472	0	0	0	0
47 / 385	Scaun sofer cu reglaj electric si memorie	618	766	0	0	0	0
	Scaun pasager reglabil pe inaltime cu suport lombar ajustabil (spatar complet rabatabil) (nu cu						
57	cod 10)	119	148	0	0	0	S
11	Scaune fata incalzite	305	378	0	0	0	0
437	Ornamente interioare aluminiu pe panouri usi / consola (nu cu Rdesign,762,851)	186	231	0	S	-	S
762	Ornamente interioare lemn "Laminated Oak"	381	472	0	-	-	-
		195	242	-	0	-	0
851	Ornamente interioare "Oyster burst" (nu cu Rdesign,762,437)	186	231	0	-	-	-
		0	0	-	0	-	0
825	Capac culisant in consola fata "Laminated Oak" (doar impreuna cu 762 ; nu cu 437/851)	42	52	0	0	-	0
289	Suport ochelari	17	21	0	0	0	0
556	Suport pentru sticla/cos de hartii (scoate din std.scrumiera spate)	34	42	0	0	0	0
346	Suport cumparaturi in portbagaj (numai impreuna cu kit reparatie pentru D4/T5)	85	105	0	0	0	0
424	Priza 12V in portbagaj	34	42	0	0	0	0
329	Cotiera spate cu suport pentru pahare	119	148	0	0	0	S
33	Pilot automat	237	294	0	S	S	S
<b>AUDIO</b>							
502	Sistem audio High Performance, 8 difuzoare, 4x40W (Radio/CD/MP3),conexiune USB	381	472	0	S	S	S
502 / 505	Sistem audio High Performance, 8 difuzoare, 4x40W (Radio/CD/MP3) + 6-CD player (fara USB)	660	818	0	-	-	-
		279	346	-	0	0	0
503	Sistem audio Premium Sound 10 difuzoare, 5x130W, Dolby Pro-LogicII,MP3,conexiune USB	855	1,060	0	-	-	-
		474	588	-	0	0	0
503 / 505	Sistem audio Premium Sound 10 difuzoare, 5x130W, Dolby Pro-LogicII+6-CD player,MP3 (fara	1,134	1,406	0	-	-	-
		753	934	-	0	0	0
235	Comenzi audio pe volan (std.Rdesign)	76	94	0	S	S	S
	Sistem de navigatie (RTI) fara TV, cu comanda pe volan (include cod 235, obligatoriu cu volan						
142	piele si cu un sistem audio din lista de optionale)	1,702	2,110	0	-	-	S
		1,626	2,016	-	0	0	-
	Bluetooth integrat (obligatoriu cu cod 235 sau 142 ; scoate din std.mufa AUX in combinatie cu						
732	sistemul audio Performance)	288	357	0	S	S	S
<b>SIGURANTA</b>							
140/ 263 /26€	Alarma Volvo cu telecomanda, senzor de inclinare / miscare	263	326	0	0	0	0
583	Sistem "keyless"	474	588	0	0	0	0
372	HomeLink EU (obligatoriu cu cod 101)	68	84	0	0	0	0
603	BLIS (numai cu cod 167)	474	588	0	0	0	0
236	Geamuri laterale antiefractie (include 595)	474	588	0	0	0	0
595	Geamuri laterale tratate hidrofug	93	115	0	0	0	0
529	Senzor de parcare cu avertizare sonora pentru mersul inapoi	390	484	0	S	S	S
322 / 114	Scaune pentru copii integrate in bancheta spate (st/dr)	271	336	0	0	0	0
	Siguranta electrica pentru copii la usile din spate						
<b>SASIU</b>							
68	Sasiu Sport (nu pentru DRIVE si D2); nu cu jante de 18" ,nu cu 21	330	409	0	0	0	0
	NIVOMAT sistem pentru mentinerea constanta a garzii la sol (nu pentru AWD, nu cu 68,nu cu						
21	jante pe 18", nu pentru DRIVE si D2)	474	588	0	0	0	0

## DOTARI OPTIONALE VOLVO V50

Cod		Pret Euro fara TVA	Pret Euro cu TVA	Kinetic	Business Ed.	Rdesign Ed.	Business Pro
<b>CULORI EXTERIOARE</b>							
19	Black Stone solid	0	0	S	S	-	S
612	Passion Red solid	0	0	-	-	S	-
614	Ice White solid	0	0	0	0	0	0
426	Silver metallic	669	830	0	0	0	0
452	Black Sapphire metallic	669	830	0	0	0	0
455	Titanium Grey pearl	669	830	0	0	0	0
481	Cosmic White pearl	669	830	0	0	-	0
490	Chameleon Blue pearl	669	830	0	0	-	0
498	Caspian Blue metallic	669	830	0	0	-	0
701	Orange flame metallic	669	830	0	0	-	0
702	Flamenco Red	669	830	0	0	0	0
477	Electric Silver metallic	847	1,050	0	0	0	0
<b>JANTE</b>							
842	16" jante aliaj, LIBRA, 205/55 R16 (numai pentru DRIVE,D2)	0	0	0	0	-	0
784	16" jante aliaj, CORDELIA, 205/55 R16	0	0	S	0	-	0
826	16" jante aliaj, CONVECTOR, 205/55 R16	0	0	0	S	-	S
787	17" jante aliaj, SERAPIS, 205/50 R17 (nu pentru DRIVE,D2)	457	567	0	0	-	0
827	17" jante aliaj, STYX WHITE, 205/50 R17	457	567	0	0	-	0
888	17" jante aliaj, SPARTACUS, 205/50 R17	457	567	0	0	-	0
659	17" jante aliaj, SPIDER, 205/50 R17	457	567	0	0	-	0
800016	17" jante aliaj,ZAURAK Diamond Cut, 205/50 R17	457	567	0	0	-	0
800017 (doar pentru 2.0,T5,D3,D4)	18" jante aliaj, ATREUS Diamond Cut, 215/45 R18 - Michelin	1372	1,701	0	0	-	0
	18" jante aliaj, ATREUS Diamond Cut, 215/45 R18	915	1,135	-	-	0	-
*800048 - (doar pentru 2.0,T5,D3,D4)	18" jante aliaj, MIDIR Diamond Cut, 215/45 R18 - Michelin	915	1,135	-	-	0	-
312	Antifurt jante aliaj	34	42	0	0	0	0

LIBRA



CORDELIA



CONVECTOR



SERAPIS



STYX WHITE



SPIDER



ZAURAK SILVER BRIGHT



SPARTACUS



ATREUS DIAMOND CUT



MIDIR



## DOTARI OPTIONALE VOLVO V50

TAPITERII	Pret Euro fara TVA	Pret Euro cu TVA	Kinetic	Business Ed.	Rdesign Ed.	Business Pro Ed.
Tapiterie Textil Boda	0	0	S	-	-	-
Tapiterie Textil/Tricotex Dalaro	237	294	O	S	-	-
Tapiterie Piele	1380	1,711	O	-	-	-
	1143	1,417	-	O	-	S
Tapiterie Piele Rdesign	0	0	-	-	S	-

COD	DENUMIRE TAPITERIE	Culoare Tapiterie	Culoare superior bord si usa	Culoare panou inferior bord si usa+consola	Culoare mocheta	Culoare covorase	Culoare insertii usa	Culoa plafon
<b>TAPITERIE TEXTIL BODA</b>								
5B77	Off Black / Off Black	Negru	Negru	Negru	Negru	Negru	Negru	Gri
5BE1	Dark Beige / Quartz beige	Gri deschis	Maro inchis	Gri	Gri	Gri	Gri	Gri
<b>TAPITERIE TEXTIL DALARO</b>								
5C77	Off Black / Off Black	Negru	Negru	Negru	Negru	Negru	Negru	Gri
5CE1	Dark Beige/ Quartz beige	Gri	Maro inchis	Gri	Gri	Gri	Gri	Gri
<b>TAPITERIE PIELE</b>								
5D77	Off Black / Off Black	Negru	Negru	Negru	Negru	Negru	Negru	Gri
5DM9	Off Black / Cacao Brown	Maro inchis	Negru	Negru	Maro inchis	Maro inchis	Maro inchis	Gri
5DF4	Off Black / Calcite	Calcite crem	Negru	Negru	Gri	Gri	Calcite crem	Gri
5DE4	Dark Beige / Calcite Cream	Calcite crem	Maro inchis	Gri	Gri	Gri	Calcite crem	Gri
5DFT	Off Black / Off Black	Negru/Calcite	Negru	Negru	Negru	Negru	Calcite crem	Gri
<b>TAPITERIE PIELE RDESIGN (numai impreuna cu pachet Rdesign)</b>								
5F7K	OffBlack / Cream	Negru/Crem	Negru	Negru	Negru	Negru/Crem	Negru	Gri

## ECHIPAMENT STANDARD VOLVO V50

### SIGURANTA

ABS	Pretensionare centuri siguranta cu blocare automata (fata/spate)
IDIS - Sistem inteligent gestionare informatii sofer	Imobilizator electronic la pornire
DSTC - Sistem dinamic control tractiune si stabilitate	Inchidere centralizata cu telecomanda
EBA - Asistare la franarea de urgenta	Lumini "Home safe"
EBL - Stopuri frana cu functie de panica	ISOFIX
SIPS - Airbag-uri laterale	"Pacos" - Comutator anulare airbag pasager
IC - Airbag-uri tip cortina	
WHIPS - Protectie impact din spate pentru scaune fata	
Airbag sofer si pasager	

### EXTERIOR

#### JANTE, SASIU, TRANSMISIE, CUTIE DE VITEZE

16" jante aliaj, CORDELIA, 205/55 R16	Servodirectie
Sasiu dinamic (T5,D3,D4)	Cutie de viteze manuala in 5 trepte (2.0)
Sasiu confort (2.0)	Cutie de viteze manuala in 6 trepte (D2, DRIVE,D3,D4)
Sasiu DRIVE -10mm mai jos vs. normal (DRIVE,D2)	Cutie de viteze optimizata - performanta ridicata/consum minim (DRIVE,D2)
Ulei transmisie frecare redusa (DRIVE,D2)	

### DESIGN

Oglinzi electrice si incalzite, in culoarea caroseriei  
Ornamente exterioare in culoarea caroseriei  
Semnalizatoare in oglinzile exterioare

### ALTELE

Filtru de particule diesel (motorizari diesel)  
Positive Temperature Control - PTC (motorizari diesel)  
Filtru de polen

### INTERIOR

#### CONFORT

Climatizare automata	Scaun sofer reglabil pe inaltime cu suport lombar reglabil
Reglaj temperatura separat sofer / pasager	Spatar scaun pasager complet rabatabil
Lampi pentru citit fata / spate	Computer de bord
Lumini interioare cu temporizare	Bancheta rabatabila (40/60)
Indicator temperatura exterioara	Priza 12 V in consola fata
Tuometru; Ceas digital	Agatatoare haina pe tetiera pasager
Geamuri electrice fata / spate (automate)	Cotiera fata cu suport pentru pahare
Oglinda incorporata in parasolar pasager	Illuminare sub bord sofer / pasager
Volan reglabil pe inaltime si telescopic (coloana deformabila)	Tetiere spate, reglabile pe inaltime
Oglinzi parasolar iluminate (sofer si pasager)	Plasa protectie bagaje
Covorase textile	Prelata portbagaj

### DESIGN

Tapiterie textil Boda	Volan 3 spate imbracat in piele
Ornamente bauxita	Schimbator de viteze imbracat in piele
Levier frana de mana imbracat in piele	Instrumente de bord watch dial (T5,D4)

### AUDIO

Sistem audio Performance Radio CD player 1 disc ,6 difuzoare, decodare MP3/WMA  
Amplificator 4X20W  
Intrare auxiliara jack 3.5"

### ALTELE

Display in limba Engleza	Triunghi reflectorizant
Kit reparatie anvelope	Scrumiera si bricheta
Trusa de prim ajutor	

### DRIVE - echipament standard suplimentar

Emblema DRIVE (aripa dreapta spate)  
Indicator schimbare viteze (Gearshift indicator)  
Servodirectie optimizata  
Sistem de control electronic al motorului optimizat  
Tehnologie START-STOP (control automat)  
Oglinda retrovizoare cu efect hellomat  
Senzor de umiditate  
Grila fata acoperita partial



## SPECIFICATII TEHNICE VOLVO V50

Motorizare	2.0	T5	D2	*DRIVE	D3	D4
Norma de poluare	EURO5	EURO5	EURO5	EURO5	EURO5	EURO5
Filtru de particule diesel	-	-	DA	DA	DA	DA
Numar cilindri	4 cilindri	5 cilindri	4 cilindri	4 cilindri	5 cilindri	5 cilindri
Numar valve	16 valve	20 valve	16 valve	16 valve	20 valve	20 valve
Capacitate cilindrica	1999	2521	1560	1560	1984	1984
Putere maxima (kw/rpm)	107(145) / 6000	169 (230) / 5000	84 (115) / 3600	84 (115) / 3600	110(150)/3500	130(177)/3500
Cuplu maxim (Nm/rpm)	185 / 4500	320 / 1500-5000	270 / 1750	270 / 1750	350/1500-2750	400/1750-2750
Acceleratie (0-100 km/h)	9.6	7.3	11.5	11.5	9.6/9.7	8.8/8.9
Viteza maxima (km/h)	210	235	195	195	210/205	220/215
Consum mediu (l/100km)	7.6	9	4.3	3.8	5.1/5.8	5.1/5.8
Emisii specifice CO2 (g/km)	176	211	114	99	134/154	134/154
Transmisie	M5	G5	M6	M6	M6/G6	M6/G6

\*) Tehnologie Start-Stop

Garantie : 24 luni fara limita de km / Garantie anticoroziune : 12 ani

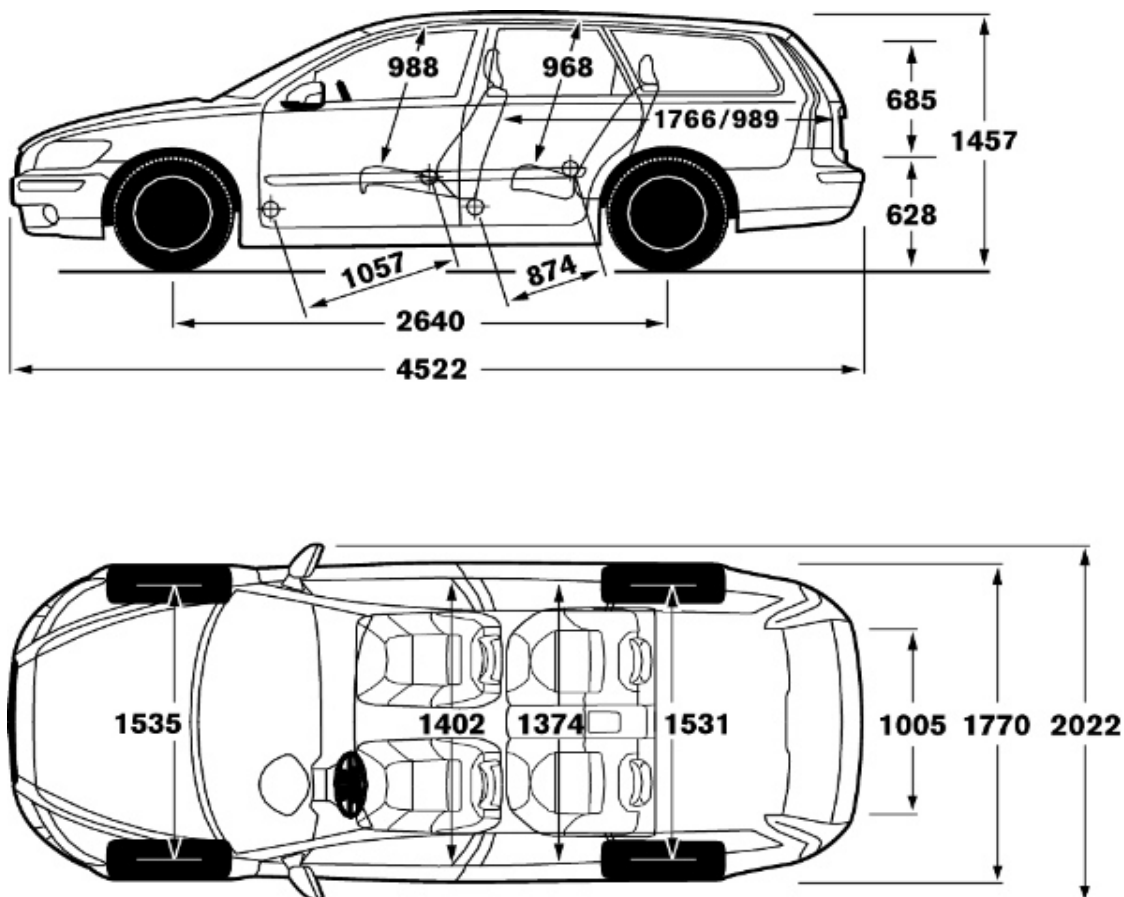

Lista de preturi valabila de la 01.05.2011.v3.Actualizare 14.11.11.Producatorul isi rezerva dreptul de a aduce modificari prezentei liste de preturi in ceea ce priveste pretul, paleta de culori, tapiteriile, echipamentul standard si optional, datele tehnice si de a intrerupe fabricarea oricarui model.Preturile se vor calcula in lei la cursul EUR/RON din ziua platii, comunicat de Dealer.